

# WASTE PAPER BIN <sup>43L</sup> F2

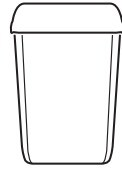

1x



4x



4x



4x

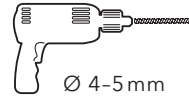

Ø 4-5 mm

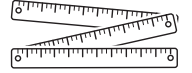

## WALL INSTALLATION

1a

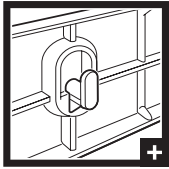

1

4-5 mm

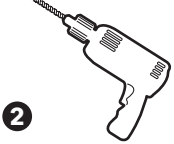

2

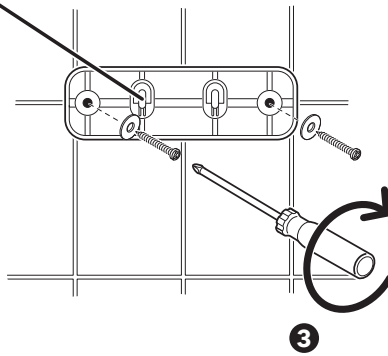
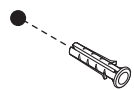

3

2a

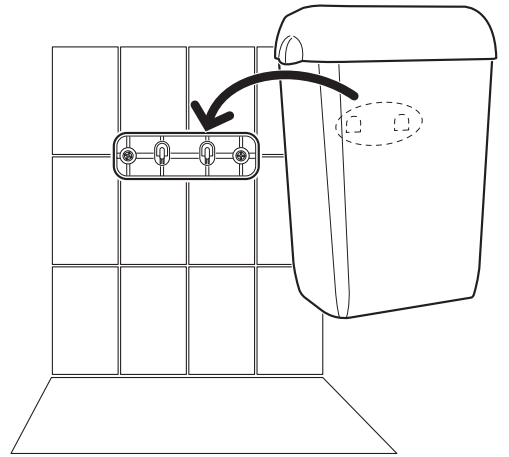

## STANDING

1b

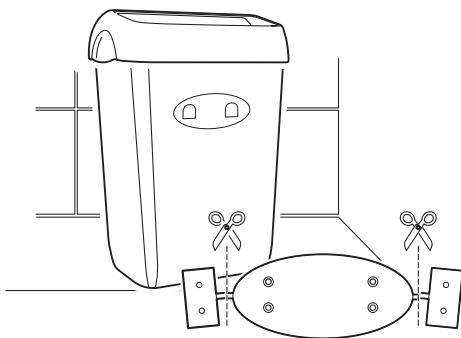

2b

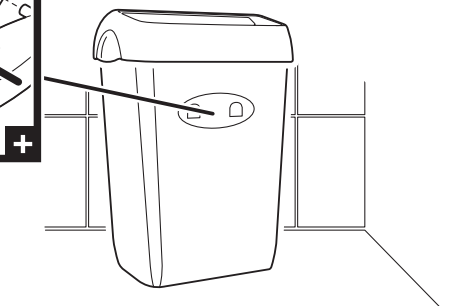
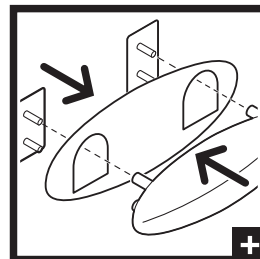

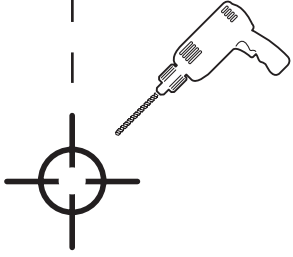

180 mm



283 mm

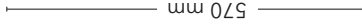

570 mm

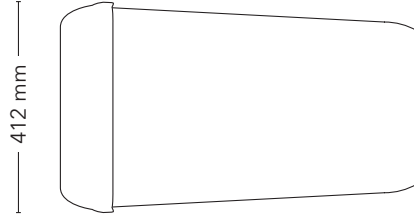

412 mm



110-  
160 mm

455-  
505 mm

